

19" CSRD TF - MESH 4 DECAL - SCALE 1:1

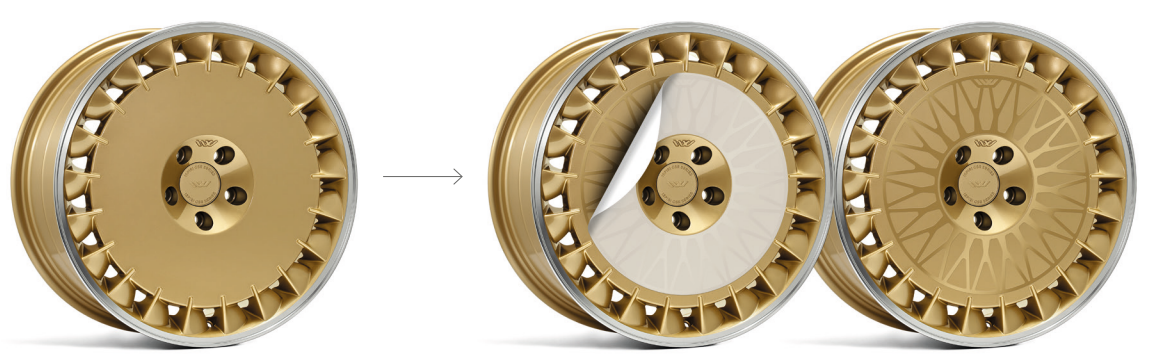

Available to buy from IW, cut from sign vinyl for extra durability. Alternatively take this template to a vehicle wrapping specialist to create your own. IW accept no responsibility for decals produced by a 3rd party.

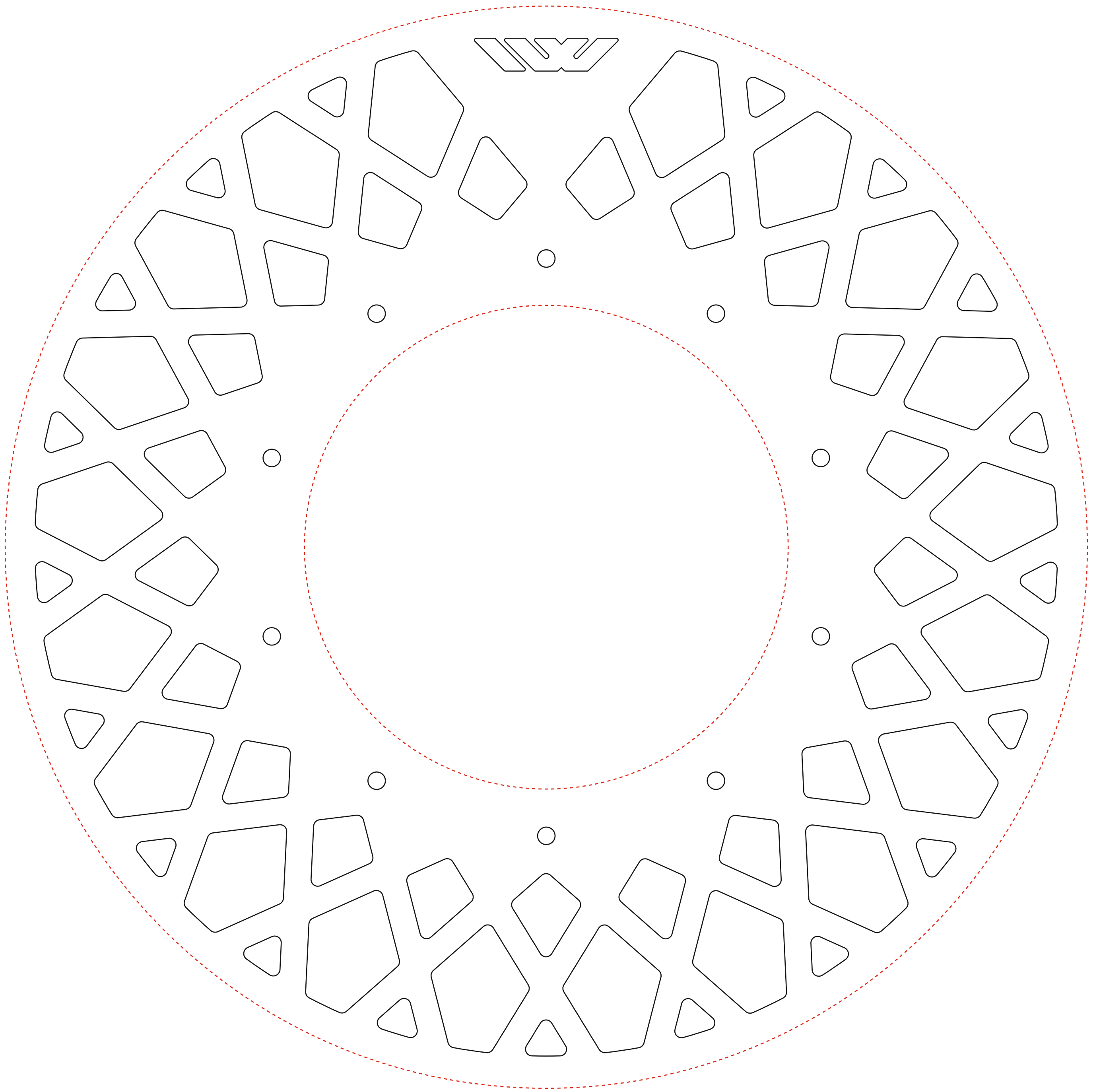

DECAL TEMPLATE

For ease of application cut decal backing paper to create a ring shaped template [marked by dotted lines above].



ACTUAL PRINT SIZE

Do not alter decal graphic in any way!

DECAL POSITION

Match decal positioning to reference below. Use the IW logo embossed on the wheel as a vertical guide.

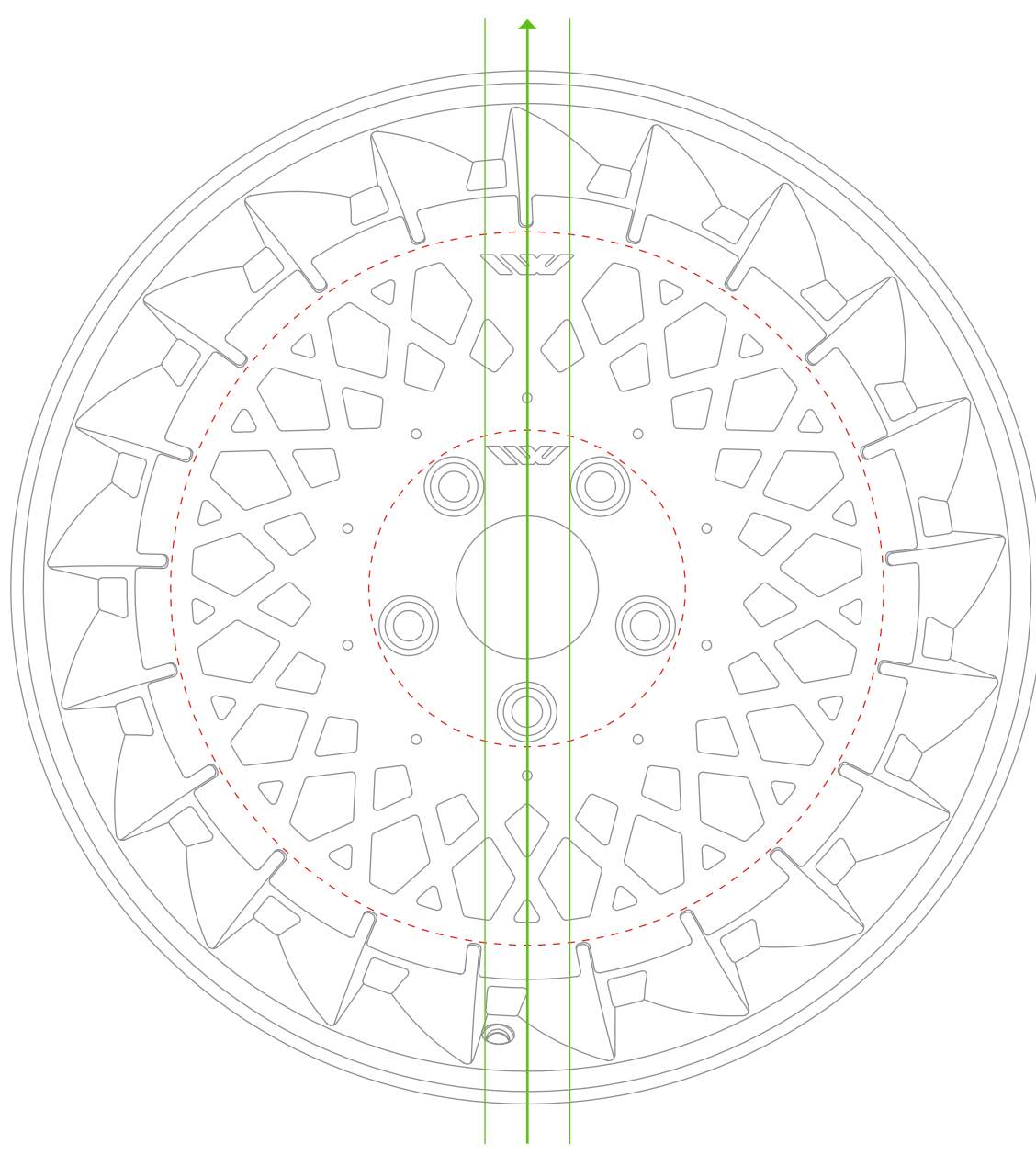

CORRECT DECAL POSITION

COLOUR OPTIONS

Below are vinyl colour combinations we prefer, use these as a guide or create your own.

VINTAGE GOLD VINYL COLOURS

Matt Gold vinyl

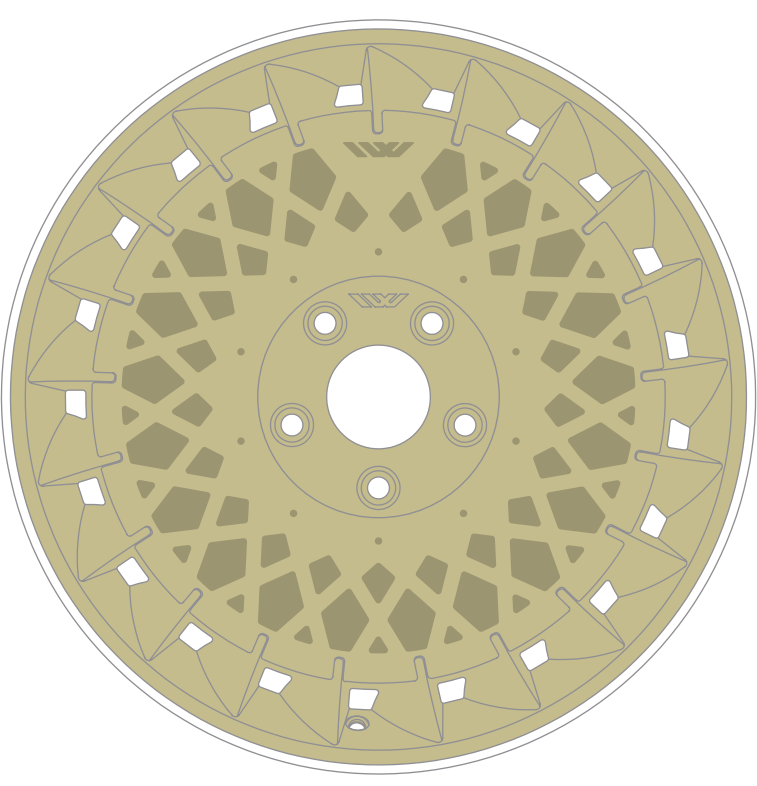

Matt White vinyl

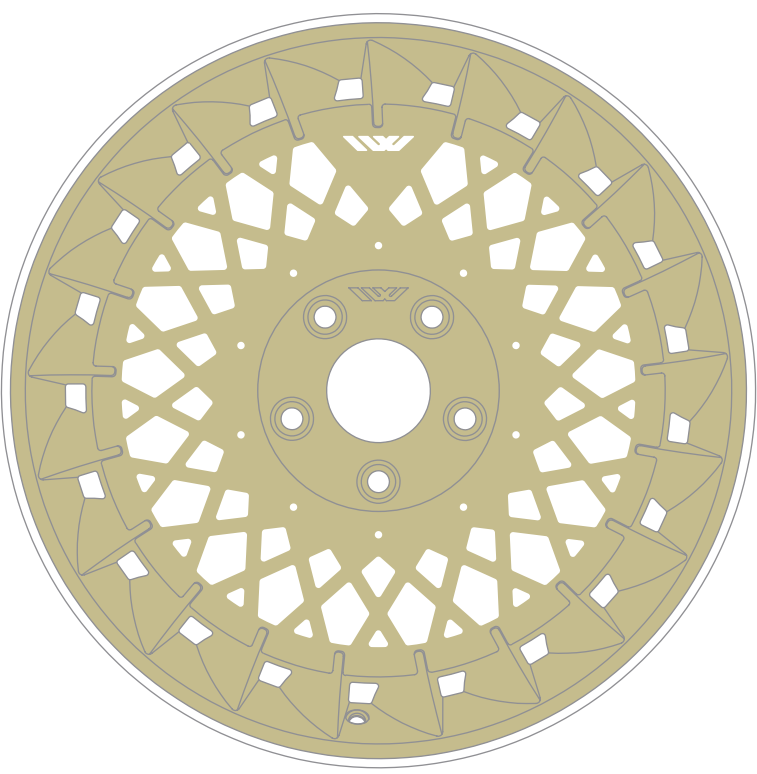

Matt Silver vinyl

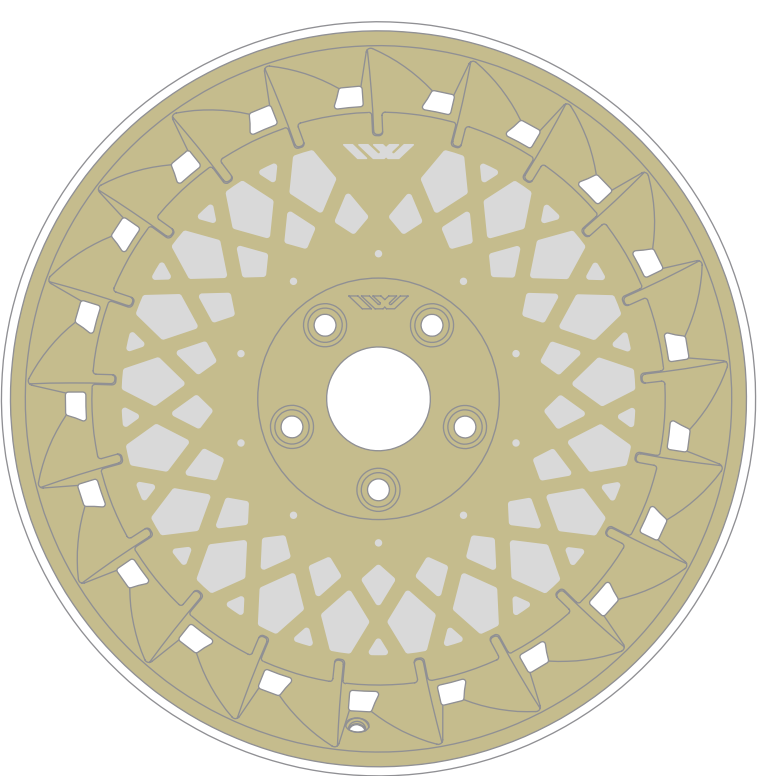

CARBON GRAPHITE VINYL COLOURS

Matt Black vinyl

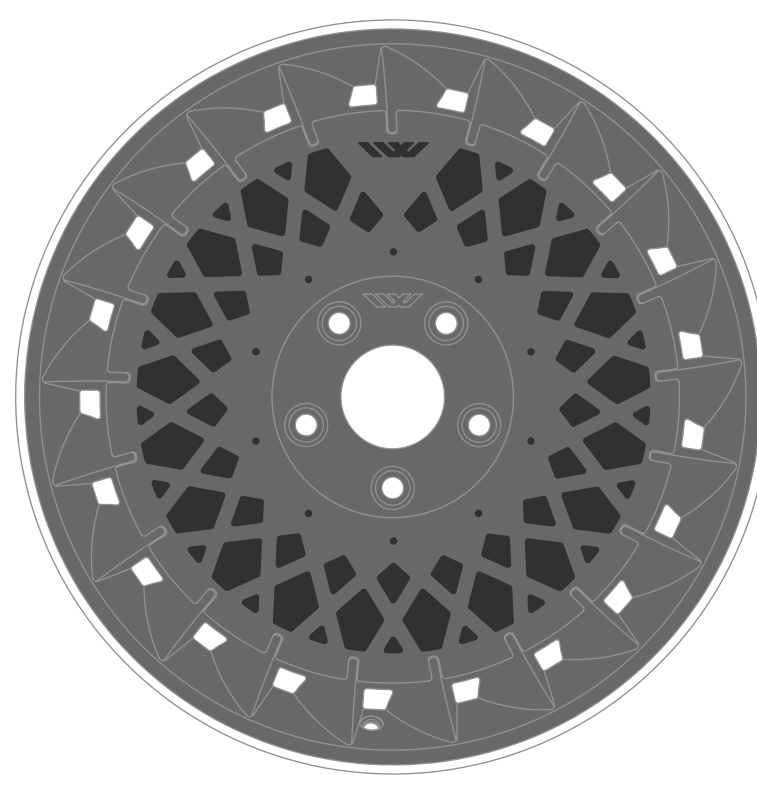

Matt White vinyl

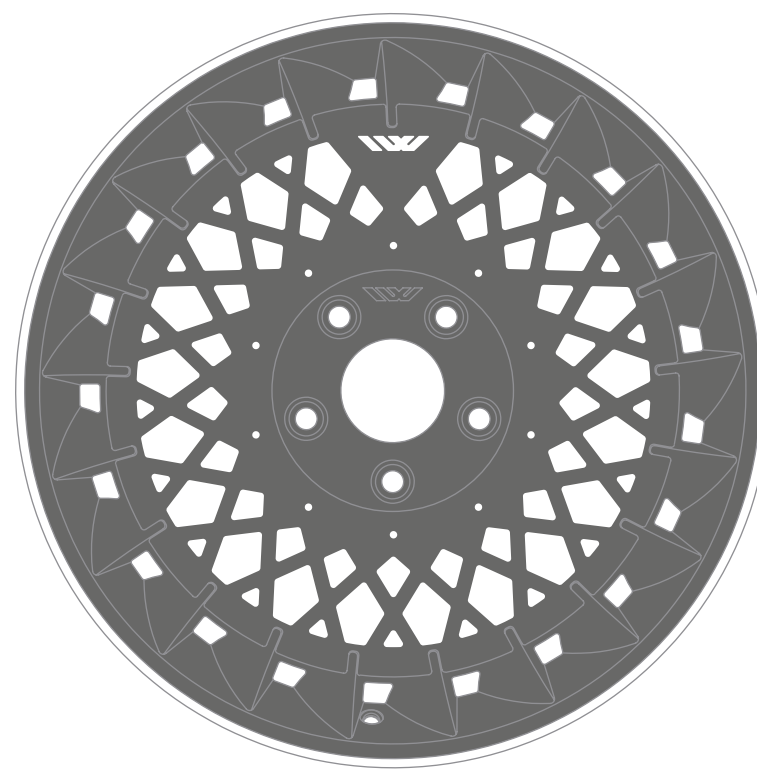

Matt Silver vinyl

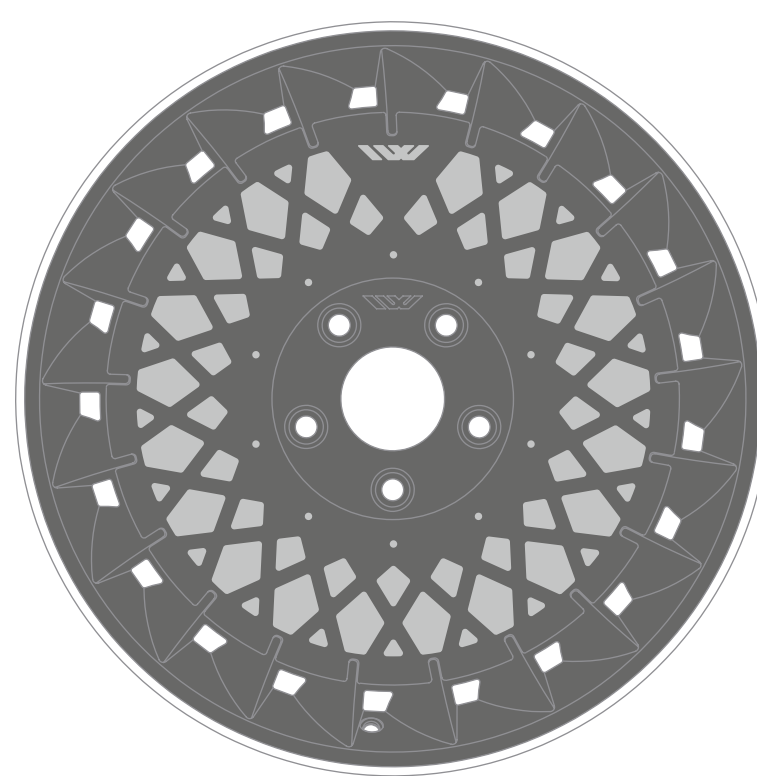

FURTHER CONSIDERATIONS

- Use sign vinyl for extra durability.
- Use a vehicle wrapping specialist to produce and install.
- Fit decals prior to wheels being mounted.

